

ICOM

INSTRUCTION MANUAL

144MHz FM TRANSCEIVER

IC-2SA

IC-2SE

Icom Inc.

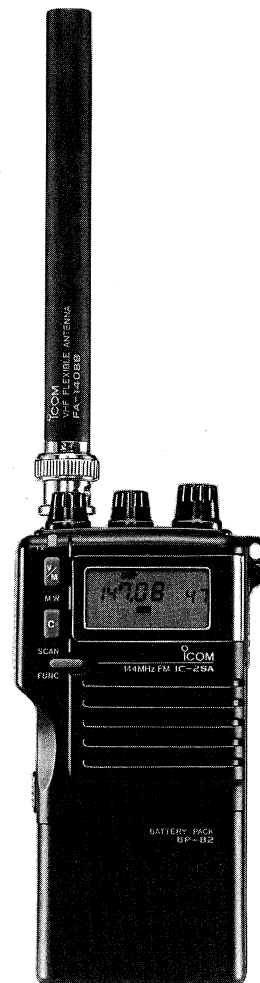

FOREWORD

This instruction manual explains basic operation of the IC-2SA/SE 144 MHz FM TRANSCEIVER. When you require additional information, refer to a separate sheet called "Tech Talk," available from your nearest Icom Dealer or Service Center.

USE IN THE NORMAL CONDITION

If one of the function guides described at right appears during operation or when first applying power, the transceiver may not operate as explained in this instruction manual.

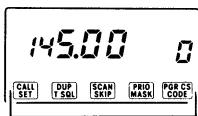

One of these guides

At that time, the transceiver should be set to normal conditions as follows:

- 1) Turn power OFF.
- 2) While pushing [LIGHT] and [V/M], turn power ON.
 - Be sure the function guide indicator disappears.

FIRST APPLYING POWER

If the transceiver seems to malfunction when first applying power, the internal rechargeable backup battery may be exhausted. This condition may occur if the transceiver is operated more than 1 week after the attached battery pack is exhausted.

At this time, the transceiver should be reset as follows:

- 1) Connect the wall charger to the top panel. (Asia version: install batteries into the battery case.)
- 2) Push and hold [MONITOR] and [LIGHT] then rotate [VOL] to turn ON power.
- 3) Turn OFF power, then wait until the battery pack is charged. (Not applicable to Asia version)

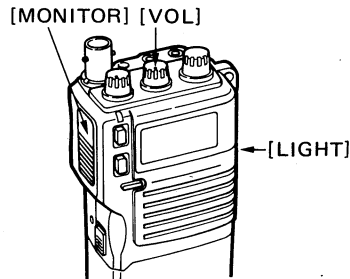
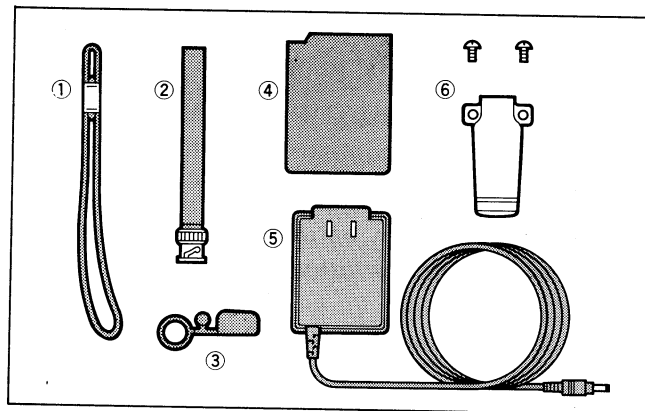

TABLE OF CONTENTS

FOREWORD	i
NORMAL OPERATING CONDITION	i
FIRST APPLYING POWER	i
TABLE OF CONTENTS	ii
UNPACKING	ii
IMPORTANT	iii
OPERATING NOTES	iii
CAUTIONS	iii
1 FEATURES	1
2 PRE-OPERATION	2 ~ 3
3 CONTROL FUNCTIONS	4 ~ 6
3-1 Switches and controls	4
3-2 Function display	6
4 BASIC OPERATION	7 ~ 10
4-1 Setting a frequency	7
4-2 Receiving	8
4-3 Transmitting	8
4-4 Repeater operation	10
5 RELATED FUNCTIONS	11 ~ 16
5-1 Call channel	11
5-2 Memory mode	12
5-3 Scanning	14
5-4 Auto power off function	16
6 MAINTENANCE	17 ~ 18
6-1 Troubleshooting	17
6-2 Backup battery	18
6-3 Cleaning	18
6-4 Resetting the CPU	18
7 SPECIFICATIONS	19

UNPACKING



① Handstrap	1
② Antenna	1
③ Rainproof cap	1
④ Battery pack (BP-82)* ¹	1
⑤ Wall charger* ²	1
⑥ Belt clip and screws	1 set

*¹ Battery case for Asia version

*² BC-74A for U.S.A. version

BC-74V for Australia version

BC-73D for Europe and Italy versions

No charger included for Asia version

IMPORTANT

READ ALL INSTRUCTIONS carefully and completely before using the transceiver.

SAVE THIS INSTRUCTION MANUAL — This instruction manual contains important safety and operating instructions for the IC-2SA/SE.

The use of non-Icom battery packs/chargers may impair transceiver performance and invalidate the warranty.

OPERATING NOTES

BE CAREFUL! When transmitting for a long time with high output power, the rear panel may become hot.

When using the BP-90 (battery case) or BP-81 (smallest battery pack), we recommend operating with low output power. Battery power will be reduced quickly if the transceiver is operated continuously using high output power.

CAUTIONS

NEVER connect the transceiver via the [DC 13.8 V] jack to an AC outlet or to a power source of more than 16 V DC. These connections will ruin the transceiver.

NEVER connect the transceiver to a power source using reverse polarity. This connection will harm internal transceiver circuitry.

NEVER allow children to touch the transceiver.

NEVER use a non-recommended charger for charging. Suggested chargers are described on p. 3.

AVOID using or placing the transceiver in areas with temperatures below -10°C ($+14^{\circ}\text{F}$) or over $+60^{\circ}\text{C}$ ($+140^{\circ}\text{F}$).

AVOID placing the transceiver in direct sunlight.

SLIM AND UNBELIEVABLY COMPACT

Transceiver dimensions are just 49 mm (1.9")W x 103.5 mm (4.1")H x 33 mm (1.3"). These are dimensions that include the BP-82 BATTERY PACK! And the rounded body design gives you a feeling of even smaller transceiver dimensions.

CONVENIENT, SIMPLE OPERATION

The IC-2SA/SE's uncomplicated design includes just 6 switches and 3 controls. This design ensures easy operation. Also, no double controls are incorporated, making operation even easier.

EXTERNAL DC POWER JACK

Another Icom innovation. Even though the IC-2SA/SE is incredibly small, we've equipped it with an external DC power jack. Operate the transceiver either with a battery pack or an external power source such as a power supply, cigarette lighter socket in a vehicle, etc. No optional DC-DC converter is necessary. And battery charging can also be performed via this jack.

5 W OUTPUT POWER

It's hard to imagine 5 W of output power coming from such a small transceiver. Yet the IC-2SA/SE achieves this when connected to a 13.8 V DC power source. Also, 3 selectable low output power levels give you amazing versatility when transmitting.

AUTO POWER OFF AND POWER SAVE FUNCTION

The IC-2SA/SE has an advanced power saver design for conserving battery pack power. When no signal is received or no switch is pushed for 5 seconds, the power save function reduces current consumption to approx. 1/4. And after 60 minutes, power is automatically turned OFF by the auto power off function.

48 MEMORY CHANNELS

The transceiver has 48 fully-programmable memory channels and one call channel. Each memory and call channel stores an operating frequency and duplex (repeater) information. Your favorite frequency can be recalled immediately.

CONVENIENT SCAN FUNCTIONS

The transceiver is equipped with 2 scan functions, VFO scan and memory scan. The scan functions repeatedly scan the entire 2 m band or all programmed memory channels. In addition, the frequency skip function skips undesired frequencies during VFO scan.

(1) CHARGING CONNECTION

Charge any new battery pack or battery packs not used for 2 months or more.

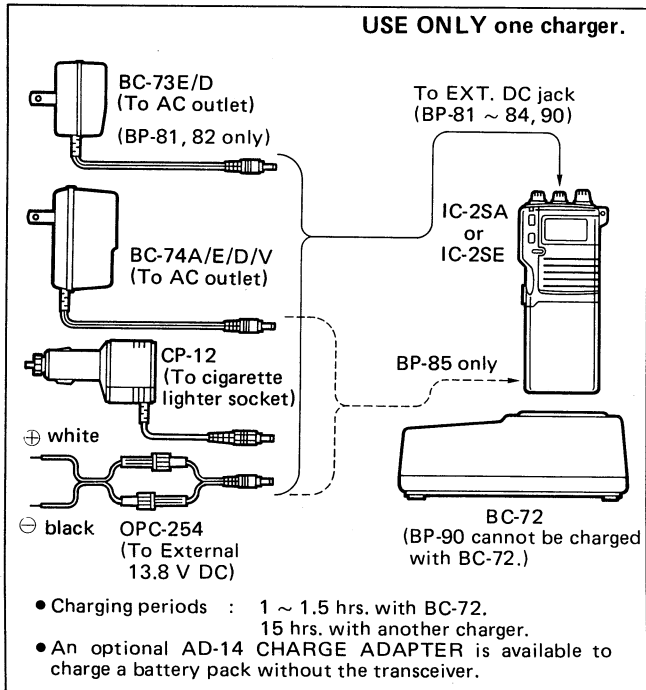

(2) BATTERY PACK CAUTIONS

1. **NEVER** throw the battery pack into fire.
2. **NEVER** disassemble the battery pack.
3. **AVOID** operating or charging the battery pack in places below 0°C (+32°F) or over +45°C (+113°F).
4. **NEVER** obstruct the holes on the bottom of the battery pack when charging with the BC-72.
5. **NEVER** charge dry batteries with the BP-90.
6. **AVOID** shorting the terminals.

(3) USING THE BATTERY PACK WISELY

The battery pack is designed to withstand recharging periods longer than 1 week or more and can be fully discharged. However, overcharging or complete discharging shorten the life of a battery. The battery pack can be recharged about 300 times but its battery life can be lengthened to about 500 times as follows:

1. Avoid overcharging. Charging times should be less than 48 hours.
2. Use battery capacity almost completely. We recommend battery charging after transmitting becomes impossible.

(4) REPLACING THE BATTERY PACK

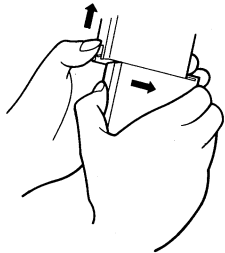

To remove the battery pack, push the **RELEASE** button upwards, and slide the battery pack to the right with the transceiver facing you.

To attach the battery pack, mate the notched ends between the battery pack and the transceiver, and slide the battery pack until a click sound from the latch is heard.

(5) BATTERY PACK OPERATING TIME

The battery packs listed below have the following operating times when transmitting at high power for 1 min. receiving for 1 min. and standby for 8 min.

BATTERY PACK	VOLTAGE	OPERATING TIME
BP-81	7.2 V	0.9 hrs.
BP-82	7.2 V	2.5 hrs.
BP-83	7.2 V	5.1 hrs.
BP-84	7.2 V	8.5 hrs.
BP-85	12.0 V	2.1 hrs.

Operating times are approximate.

Operating times may be longer when transmitting at low power or when avoiding continuous operation for long periods.

When operating at temperatures below 0° C (+32° F), operating times may decrease.

(6) CONNECTING SUPPLIED ACCESSORIES

● ANTENNA AND DUSTPROOF CAP

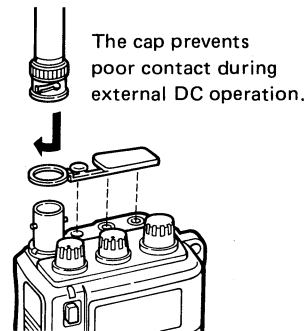

● HANDSTRAP

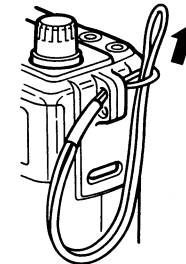

● BELT CLIP

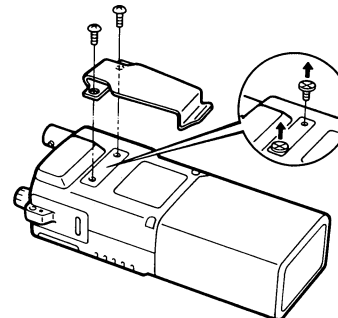

Remove the plastic screws before attaching the belt clip.

3

CONTROL FUNCTIONS

3-1 Switches and controls

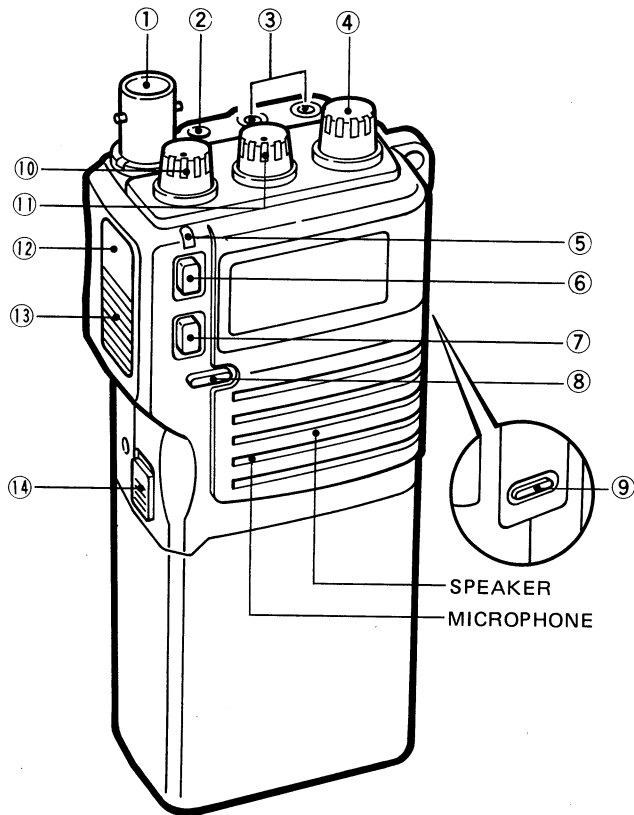

① ANTENNA CONNECTOR

Connects the supplied flexible antenna. (p. 3)

② EXTERNAL DC POWER JACK [DC 13.8 V]

Connects the supplied wall charger* for charging the attached battery pack.

Allows operation with a 13.8 V external DC power source. Use an optional CP-12 when using a cigarette lighter socket as a power source; use an optional OPC-254 power cable when using an external power supply. The wall charger cannot be used to operate the transceiver.

* Not included with some versions.

③ EXTERNAL SPEAKER AND MICROPHONE JACKS [SP]/[MIC]

Connect an optional HM-46 SPEAKER-MICROPHONE or HS-51 HEADSET, if required. The internal speaker and microphone will not function when either is connected.

④ TUNING CONTROL

Sets an operating frequency or a memory channel.

⑤ TRANSMIT/RECEIVE INDICATOR

Lights up in green when squelch opens; lights up in red when transmitting.

⑥ VFO/MEMORY SWITCH [V/M]

Selects VFO or MEMORY mode (p. 12).

After pushing [FUNC], activate "memory programming" (p. 13), "memory transferring" (p. 13) or "call channel programming" (p. 11).

⑦ CALL CHANNEL SWITCH [C]

Calls up the user-programmed call channel (p. 11).

After pushing [FUNC], activates scanning (p. 15).

NOTE: When [C] functions for another operation, turn power OFF. And then turn power ON while pushing [LIGHT] and [V/M].

⑧ FUNCTION SWITCH [FUNC]

Activates the secondary function of other switches.

⑨ LIGHT SWITCH [LIGHT]

Turns ON the display backlight.

After pushing [FUNC], activates the lock function.

⑩ SQUELCH CONTROL [SQL]

Sets the squelch threshold point for audio noise mute.

⑪ VOLUME CONTROL [VOL]

Turns power ON and adjusts the audio level.

⑫ MONITOR SWITCH [MONITOR]

Opens the squelch (p. 8).

Checks the transmit frequency when Duplex is selected (p. 10).

After pushing [FUNC], selects -Duplex, +Duplex or Simplex (p. 10).

⑬ PTT SWITCH

Push and hold to transmit; release to receive.

After pushing [FUNC], selects High or Low output power (p. 9).

⑭ BATTERY PACK RELEASE BUTTON

Opens latch for battery pack removal when pushed upwards (p. 3).

3 CONTROL FUNCTIONS

3-2 Function display

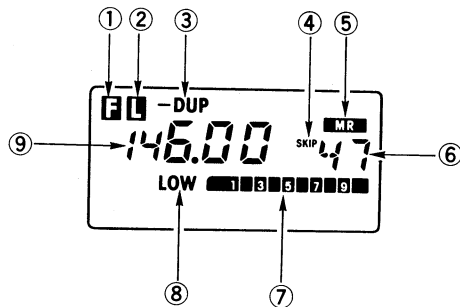

① FUNCTION INDICATOR

Appears when [FUNC] is pushed. When no switch is pushed for 5 sec. after [FUNC] is pushed, the indicator disappears.

② LOCK INDICATOR

Appears when the lock function is activated by pushing [FUNC] + [LIGHT] in sequence.

③ DUPLEX INDICATOR

"DUP" or "-DUP" appears when Duplex is selected by pushing [FUNC] + [MONITOR] in sequence (p. 10).

④ SKIP INDICATOR

Blinks during VFO scan (p. 15).

Appears on the memory channel programmed as the skip frequency (p. 15).

⑤ MEMORY INDICATOR

Appears when MEMORY mode is selected (p. 12).

Blinks in memory scan (p. 15).

⑥ MEMORY CHANNEL READOUT

Shows selected memory channel number.

"C" appears when the call channel is called up (p. 11).

⑦ S/R F INDICATOR

Shows relative signal strength when receiving, and output power selection when transmitting.

⑧ LOW POWER INDICATOR

Appears when low output power is selected by pushing [FUNC] + [PTT] in sequence (p. 9).

Low output power is selectable at 3 levels (p. 9).

⑨ FREQUENCY READOUT

Shows an operating frequency.

4-1 Setting a frequency

- 1) Rotate [VOL] to turn power ON.
- 2) Be sure VFO mode is selected.
 - If "MR" appears above the memory channel number, push [V/M] to select VFO mode.
- 3) Rotate the tuning control to set an operating frequency.

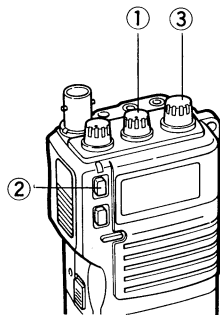

■ USING THE 100 kHz TUNING STEP

The 100 kHz tuning step provides quick frequency selection.

- 1) Push [FUNC] then rotate the tuning control.
- 2) Push [FUNC] again to return to normal step operation.

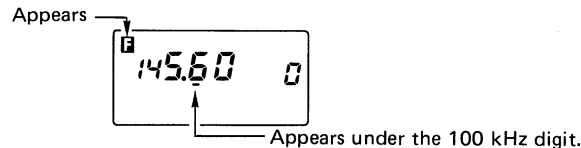

[EXAMPLE] Setting a frequency using the tuning control only. (Displays are shown for the U.S.A. version.)

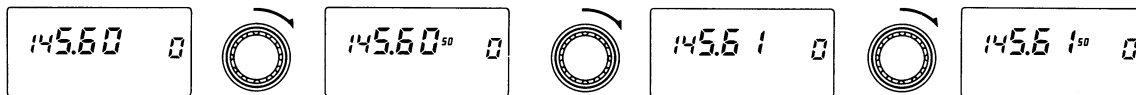

[EXAMPLE] Setting a frequency using the tuning control with the [FUNC] switch.

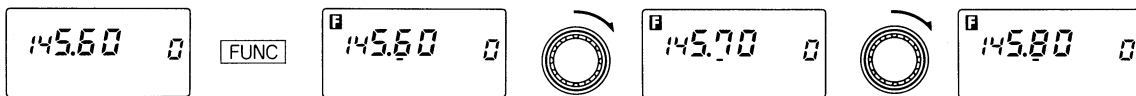

4 BASIC OPERATION

4-2 Receiving

- 1) Set [SQL] control to maximum counterclockwise.
- 2) Rotate [VOL] to turn power ON and adjust audio volume.
- 3) Rotate [SQL] clockwise until noise disappears.
- 4) Set the operating frequency.
 - See Section 4 - 1 for details.
- 5) When a signal is received on a set frequency:
 - Squelch opens and audio is emitted from the speaker.
 - The S/RF indicator shows relative signal strength.
- 6) Use [MONITOR] when a weak signal cannot open the squelch completely.

4-3 Transmitting

CAUTION: Transmitting without an antenna may damage the transceiver.

NOTE: To prevent interference, listen on the frequency before transmitting.

- 1) Set the operating frequency.
 - See Section 4 - 1 for details.
- 2) Push and hold the PTT switch to transmit.
 - The [TX] indicator lights up in red.
 - The S/RF indicator shows output power selection.
- 3) Speak into the microphone using your normal voice level.
 - **DO NOT** hold the transceiver too closely to your mouth or speak too loudly. This may distort the signal.
- 4) Release the PTT switch to receive.

■ SELECTING OUTPUT POWER

Output power can be selected for High and 3 levels of Low power. Select your desired output power, depending on your communication distance.

● SELECTING HIGH OR LOW OUTPUT POWER

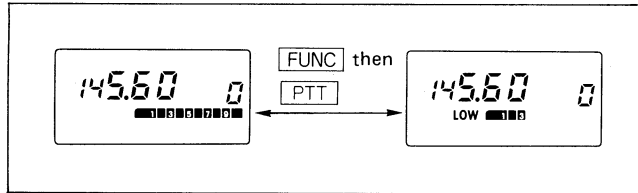

- 1) Push [FUNC] then push the PTT switch.
 - "LOW" appears when Low power is selected.
- 2) Push [FUNC] again, then push the PTT switch.
 - High output power is selected.

● SELECTING 1 OF 3 LOW OUTPUT POWER SETTINGS

POWER SELECTION	S/RF INDICATOR	OUTPUT POWER	
		At 13.8 V DC	With BP-82
LOW 1	LOW █ █ █ █	0.5 W	0.5 W
LOW 2	LOW █ █ █ █ █	1.5 W	1.5 W
LOW 3	LOW █ █ █ █ █ █ █	3.5 W	2.0 W
HIGH	█ █ █ █ █ █ █ █ █ █	5.0 W	2.0 W

- 1) Push [FUNC].
- 2) Push and hold the PTT switch then rotate the tuning control.
 - The S/RF indicator shows output power selection as described above.

4 BASIC OPERATION

4-4 Repeater Operation

When operating the transceiver with a station through a repeater, the repeater transmits your signal, allowing you to communicate with long distance stations even when low output power is selected.

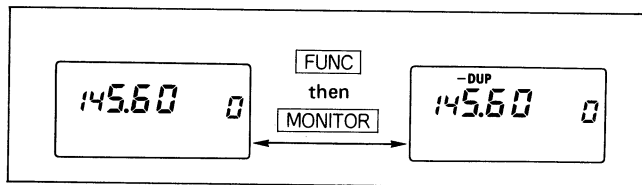

- 1) Set the receive frequency (repeater output frequency).
- 2) Push [FUNC] then push [MONITOR] to select –Duplex.
 - Shift frequency is set at 600 kHz.
 - Each push of [FUNC] and [MONITOR] in sequence selects –Duplex → +Duplex → Simplex.
- 3) Push and hold the PTT switch to transmit.
- 4) Release PTT to receive.
- 5) Push [MONITOR] to check the repeater input frequency.

■ 1750 Hz TONE CALL (Europe version)

- 1) Quickly push the PTT switch 2 times and briefly hold the switch down (second push).
 - A 1750 Hz tone is transmitted.
- 2) Release and then push the PTT switch again to transmit your voice signal.
 - For UK repeaters, the time period between the PTT switch release and push must be under 0.5 sec.

A 1750 Hz tone signal can also be transmitted by pushing [PTT] while pushing [LIGHT].

Some repeaters require a period of less than 0.5 sec. between the above steps 1 and 2.

■ SUBAUDIBLE TONE ENCODER

If a repeater requires a subaudible tone, an optional UT-50 TONE SQUELCH UNIT or UT-51 SUBAUDIBLE TONE ENCODER UNIT is necessary. Refer to a separate sheet called "Tech Talk," available from your nearest Icom Dealer or Service Center.

5-1 Call channel

A one-touch access call channel is provided for using your most often used frequency. The call channel is separate from memory channels.

(1) ACCESSING THE CALL CHANNEL

- 1) Push [C] to call up the call channel.
- 2) Push [C] again to return to the previous mode.

(2) PROGRAMMING THE CALL CHANNEL

- 1) Set the transceiver in VFO mode using [V/M].
- 2) Set the desired frequency (and Duplex, if desired) to be programmed.
- 3) Push [C] to call up the call channel.
- 4) Push [FUNC], and then push and hold [V/M] to program.
 - The displayed frequency is changed to the desired frequency.

[EXAMPLE] Accessing the call channel.

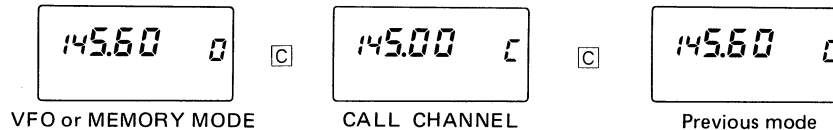

[EXAMPLE] Writing 145.600 MHz into the call channel.



5 RELATED FUNCTIONS

5-2 Memory mode

The transceiver has 48 memory channels for storing your most often used frequencies for use with repeaters, group calls, etc.

When first applying power or after resetting, memory channels 10 ~ 47 are blank.

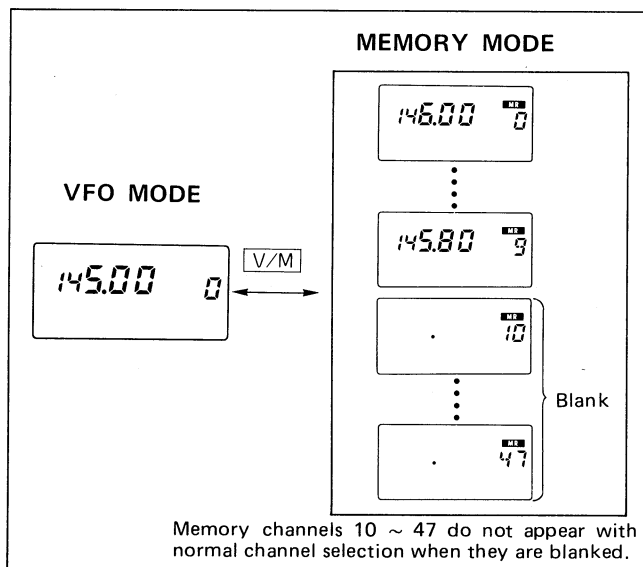

(1) SELECTING A MEMORY CHANNEL

- 1) Set the transceiver in MEMORY mode using [V/M].
- 2) Rotate the tuning control to select the desired memory channel.
- 3) Push [V/M] to return to VFO mode.

NOTE: Only programmed channels can be selected.

(2) SELECTING BLANK MEMORY CHANNELS

- 1) Set the transceiver in MEMORY mode using [V/M].
- 2) Push [FUNC] then rotate the tuning control.
 - All memory channels including blank channels can be selected.
- 3) Push [V/M] to return to VFO mode.

(3) PROGRAMMING THE MEMORY CHANNEL

- 1) Set the transceiver in MEMORY mode using [V/M].
- 2) Rotate the tuning control to select the memory channel to be programmed.
 - To select a blank channel, push [FUNC] then rotate the tuning control.
- 3) Push [V/M] to select VFO mode.
- 4) Set the desired frequency (and Duplex, if desired).
- 5) Push [FUNC], then push and hold [V/M] until 3 short beeps are heard.

(4) TRANSFERRING MEMORY CONTENTS TO VFO

Copy and transfer the displayed memory contents into VFO mode. This function is useful for searching for signals around the memorized frequency.

- 1) Select MEMORY mode, and then set the memory channel to be transferred.
- 2) Push [FUNC], and then push and hold [V/M] until 3 short beeps are heard.
 - The memory contents are transferred into VFO mode.
 - The memory contents are not erased.

[EXAMPLE] Writing 145.755 MHz into memory channel 40.

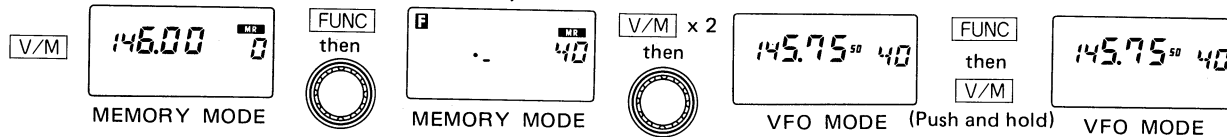

[EXAMPLE] Transferring the contents of memory channel 9 into VFO mode.

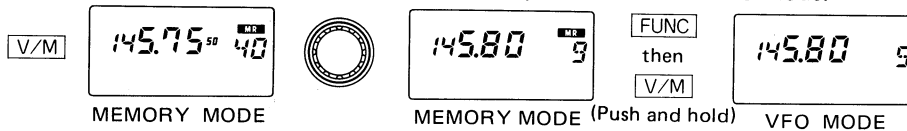

5 RELATED FUNCTIONS

5-3 Scanning

(1) SCAN TYPES

• VFO SCAN

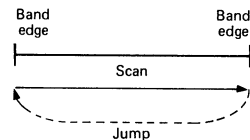

Repeatedly scans all frequencies in the entire 144 MHz band. The frequency skip function can be used.

• MEMORY SCAN

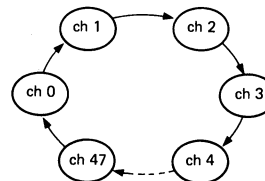

Repeatedly scans all memory channels in sequence.

• SCANNING DIRECTION

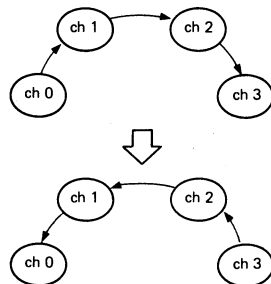

Scan normally operates in an upward direction. Scanning, however, can be selected in a downward or upward direction by rotating the tuning control.

• FREQUENCY SKIP FUNCTION

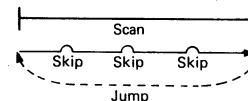

Skips unwanted frequencies such as CW transmissions that inconveniently stop scanning. 38 frequencies can be programmed as the skip frequency using memory channels 47 ~ 10.

(2) SCANNING OPERATION

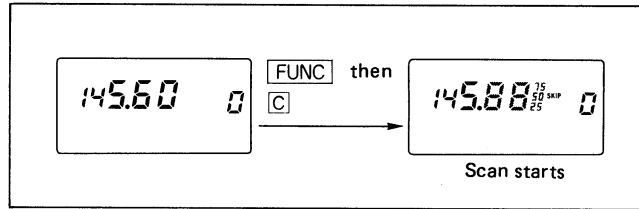

- 1) Set the transceiver in the desired mode using [V/M] :
 - VFO mode for VFO scan.
 - MEMORY mode for memory scan.
- 2) Rotate [SQL] until noise is muted.
- 3) Push [FUNC] then push [C] to start a scan.
- 4) When you wish to change the scanning direction downwards or upwards, rotate the tuning control.
- 5) When a signal is received, scanning stops for 10 sec.
 - If the signal disappears while scanning pauses, scanning resumes after approx. 2 sec.
 - Scanning can be manually resumed by rotating the tuning control.
- 6) To cancel scanning, push [C] or [V/M] 2 times.

(3) FREQUENCY SKIP FUNCTION

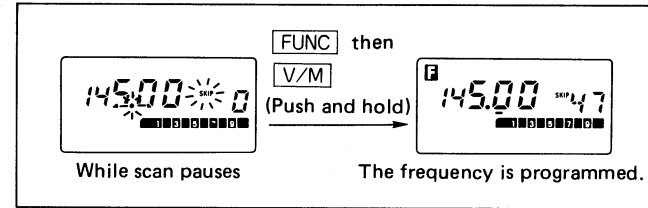

- 1) Start VFO scan:
 - While in VFO mode, push [FUNC] then push [C].
- 2) While VFO scan is paused with an unwanted signal, push [FUNC] then push and hold [V/M].
 - Memory channel number 47 appears for a moment.
 - The channel number decreases when programming the next frequency.

5 RELATED FUNCTIONS

5-4 Auto power off function

The transceiver has an auto power off function. If you forget to turn OFF the transceiver, the function automatically turns OFF the receiver and transmitter circuits 60 minutes after a switch is pushed and the squelch is closed.

After the circuits are OFF, the function display shows clock time, and then the transceiver stops operating.

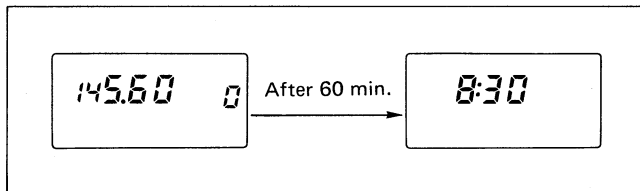

To operate the transceiver, turn power OFF then ON again.

6-1 Troubleshooting

PROBLEM	POSSIBLE CAUSE	SOLUTION	REF.
<ul style="list-style-type: none"> • No power comes ON. 	<ul style="list-style-type: none"> • Battery pack requires charging. • Poor connection between the battery pack and the transceiver. 	<ul style="list-style-type: none"> • Charge the battery pack. • Clean debris from the terminals of the battery pack and the transceiver. 	p. 2
<ul style="list-style-type: none"> • No sound comes from the speaker. 	<ul style="list-style-type: none"> • [SQL] turned too far clockwise. • Battery pack requires charging. • Power off timer is activated. • An external speaker or earphone is connected. 	<ul style="list-style-type: none"> • Rotate [SQL] counterclockwise. • Charge the battery pack. • Turn power OFF and ON again. • Unplug speaker or earphone. 	p. 8 p. 2 p. 16
<ul style="list-style-type: none"> • No transmitting is possible or only Low power can be used. 	<ul style="list-style-type: none"> • Battery pack requires charging. • Low power position is selected. 	<ul style="list-style-type: none"> • Charge the battery pack. • Select High output power. 	p. 2 p. 9
<ul style="list-style-type: none"> • Frequency cannot be set. 	<ul style="list-style-type: none"> • Lock function is activated. • Call channel is selected. 	<ul style="list-style-type: none"> • Turn OFF the function. • Push [C] to return to VFO or MEMORY mode. 	p. 5 p. 11
<ul style="list-style-type: none"> • Only memory channels 0 ~ 9 can be used. 	<ul style="list-style-type: none"> • Memory channels 10 ~ 47 are in blank status. 	<ul style="list-style-type: none"> • Select a memory channel after pushing [FUNC]. 	p. 12
<ul style="list-style-type: none"> • Scan does not operate. 	<ul style="list-style-type: none"> • Call channel is selected. • Squelch is open. • The transceiver is in the special operating condition. 	<ul style="list-style-type: none"> • Set in VFO or MEMORY mode. • Rotate [SQL] clockwise. • While pushing [LIGHT] and [V/M], turn power ON. 	p. 11 p. 15 p. i
<ul style="list-style-type: none"> • The [C] switch cannot call the call channel. 	<ul style="list-style-type: none"> • The transceiver is in the special operating condition. 	<ul style="list-style-type: none"> • While pushing [LIGHT] and [V/M], turn power ON. 	p. i
<ul style="list-style-type: none"> • The contents of the memories are erased. 	<ul style="list-style-type: none"> • The backup battery is exhausted because no charging has been performed for a long time. 	<ul style="list-style-type: none"> • Charge the battery pack (backup battery is charged simultaneously). 	p. 18

6 MAINTENANCE

6-2 Backup battery

The transceiver is equipped with a rechargeable lithium backup battery for retaining memory information. The backup battery is automatically charged when a battery pack is connected. Backup battery replacement is therefore not necessary every 5 years.

CAUTION: Attach the charged battery pack and disconnect an external DC power cable when not using the transceiver. Otherwise, the internal backup battery may discharge after 1 week.

6-3 Cleaning

If the transceiver becomes dusty or dirty, wipe it clean with a dry, soft cloth.

AVOID the use of chemical agents such as benzine or alcohol, as they may damage the transceiver surfaces.

6-4 Resetting the CPU

When the function display displays erroneous information, the CPU should be reset before sending the transceiver to an Icom Dealer or Service Center.

BE CAREFUL! After resetting the CPU, all information you have programmed into memory channels is erased.

- 1) Turn power OFF.
- 2) While pushing [LIGHT] and [MONITOR], turn power ON.
- 3) The CPU is initialized, then the following frequency appears:
 - 146.01 MHz U.S.A., Asia versions
 - 145.00 MHz Europe, Italy and Australia versions

■ GENERAL

- Frequency coverage :

MODEL	VERSION	FREQUENCY COVERAGE
IC-2SA	U.S.A.	140.00 ~ 150.00*
	Asia	
IC-2SE	Italy	
IC-2SA	Australia	144.00 ~ 148.00
IC-2SE	Europe	144.00 ~ 146.00

Unit : MHz
- * Specifications guaranteed
144.00 ~ 148.00 MHz
- Mode : FM (F3)
- Antenna impedance : 50 Ω unbalanced
- Power supply requirement : 6 ~ 16 V DC negative ground or battery packs BP-81 ~ 85, BP-90
- Current drain : Transmit
 - High 1200 mA (typical)
 - Low 450 mA (typical)
 Receive
 - Max. audio 210 mA (typical)
 - Power saved 16 mA (typical)
- Usable temperature range : $-10^{\circ}\text{C} \sim +60^{\circ}\text{C}$ ($+14^{\circ}\text{F} \sim +140^{\circ}\text{F}$)
- Dimensions (with BP-82) : 49(W) x 103.5(H)* x 33(D) mm
1.9(W) x 4.1(H)* x 1.3(D) in
* Asia version (with BP-90) :
123 mm (4.8 in)
Projections not included
- Weight (with BP-82) : 270 g (9.5 oz)
Asia version (with BP-90) :
315 g (11.1 oz)

■ TRANSMITTER

- Output power : High 5.0 W
(at 13.8 V DC) Low 3.5/1.5/0.5 W (selectable)
- Modulation system : Variable reactance frequency modulation
- Max. frequency deviation : ± 5 kHz
- Spurious emission : Less than -60 dB
- Microphone impedance : 2 k Ω
- Duty cycle : 1:3 (min) (Transmit : Receive)

■ RECEIVER

- Receive system : Double conversion superheterodyne
- Intermediate frequency : 1st 30.875 MHz 2nd 455 kHz
- Sensitivity : Less than $0.18 \mu\text{V}$ for 12 dB SINAD
- Audio output power : More than 200 mW at 10 % distortion with an 8 Ω load

All stated specifications are subject to change without notice or obligation.

Count on us!

A-5068S-1EX-②
Printed in Japan
Copyright © 1990 by Icom Inc.

Icom Inc.
6-9-16, Kamihigashi, Hirano-ku, Osaka 547, Japan